

TYPHOON



TOWER

OWNER'S MANUAL

FORWARD

Thank you for choosing a CMC product. Your new CMC Typhoon Tower was engineered to provide you with the ultimate wake boarding/skiing experience. Each part of the Typhoon Tower has been precision machined from the highest quality material to ensure trouble free service. When installed properly, your Typhoon Tower will provide years of enjoyment, please take time to pay great attention to detail during installation. Your patience will be rewarded with great wake board/skiing performance and a super new look for your boat.

INSTALLATION

Before beginning the installation of your new tower, please read through these instructions completely. We have provided photos of various steps of the installation process.

Your Typhoon Tower has been packaged with great care to prevent any damage and to guarantee that all required parts are included. For proper installation the following items should be included in your Typhoon Tower box:

ITEM #9500 TYPHOON TOWER

1. One 9572 header assembly
2. One 9577 port rear tube assembly
3. One 9579 starboard rear tube assembly
4. One 9581 port front tube assembly
5. One 9583 starboard front tube assembly
6. One 9585 rack assembly
7. Eight 9557 wear plates
8. Two 9541 brace plates
9. One 9553 all-round pedestal white light w/black body
10. Three 6039 6-32 x $\frac{3}{4}$ " Phillips pan head type F tapping screws
11. One 9554 18-4 shielded cable x 20'
12. One 9551 Typhoon Tower panel decal
13. Two 9587 brace plate decals
14. Four 9588 tube decals
15. Four 9552 shock cord assemblies
16. Four 9591 $\frac{1}{4}$ " - 20 x 2 $\frac{1}{2}$ " socket button head cap screws
17. Four 9326 $\frac{1}{4}$ " - 20 hex cap nuts
18. Four 6041 $\frac{1}{4}$ " lock washers

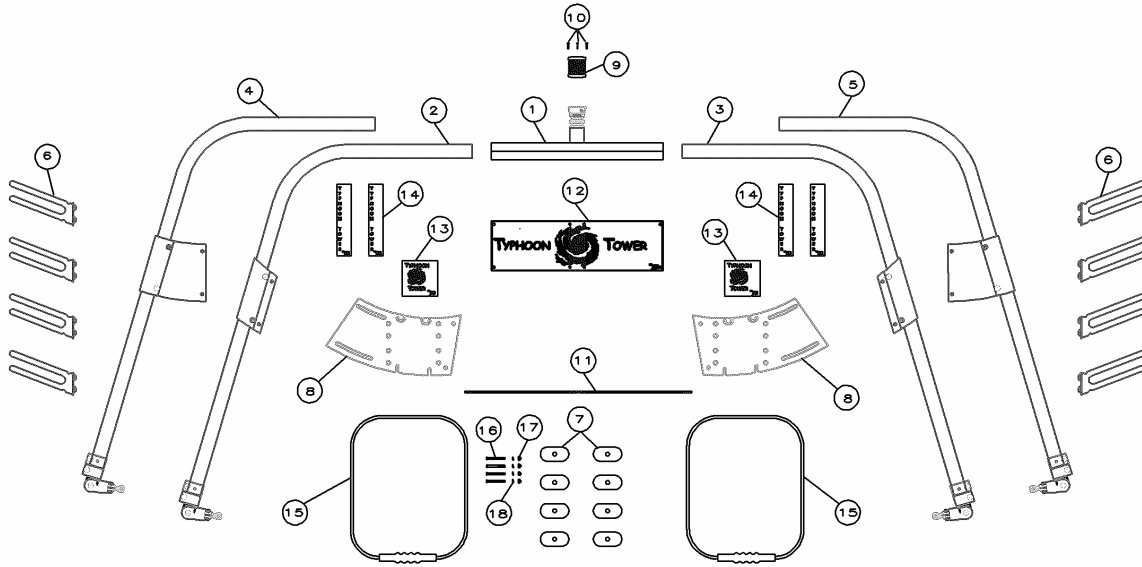

DIAGRAM 1

Prior to beginning assembly we recommend designating a large flat area to lay out all parts of the tower. It will require a minimum of two people to mount the tower to your boat.

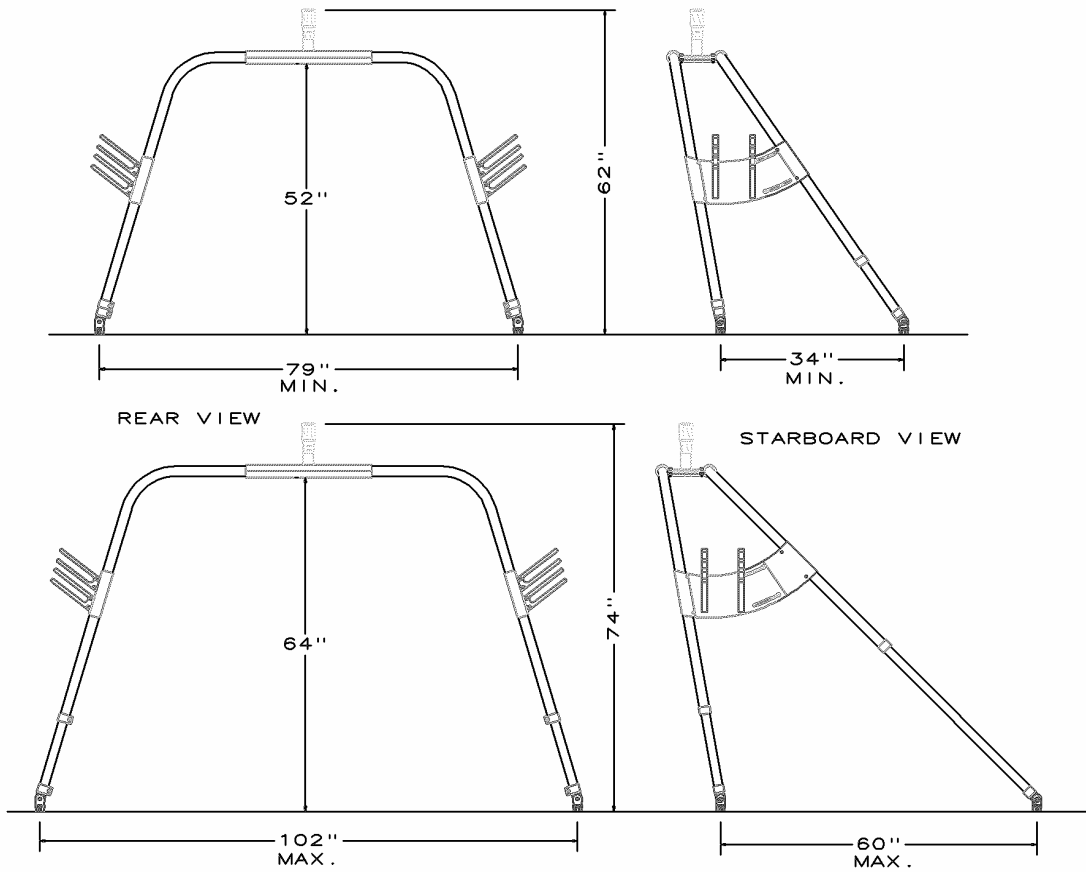

DIAGRAM 2

WARNING

Installation of the tower requires precise measurements and holes must be drilled in your boat. We recommend the CMC Typhoon Tower to be installed by your local marine dealer.

TOOL REQUIREMENTS

One power drill with 1/2" drill bit
One 5/16" hex key (Allen) socket
One 3/8" hex key (Allen) socket
One 7/32" hex key (Allen) socket
One torque wrench that will adjust to 30 foot pounds and required sockets
One Phillips screw driver
One 3/4" end wrench

ASSEMBLY OF TOWER

STEP 1: First, remove the panel from the bottom of the header assembly as shown in Figs. 1 & 2. Next wire the tower for the navigational light that will be located at the top of the pedestal of the header. You will need to decide if you will want to detach the back of the tower to tilt it forward for storage or detach the front of the tower to tilt toward the back for storage. You will want to run the wire cable through one of the tubes that pivots that is nearest where you want to connect to a switch for the light. This particular boat owner wants to tilt the tower forward when storing his boat in the garage. Therefore, wiring for the navigational light will need to be through one of the front tubes nearest his switch. For this boat it will be the front starboard side.



FIG. 1

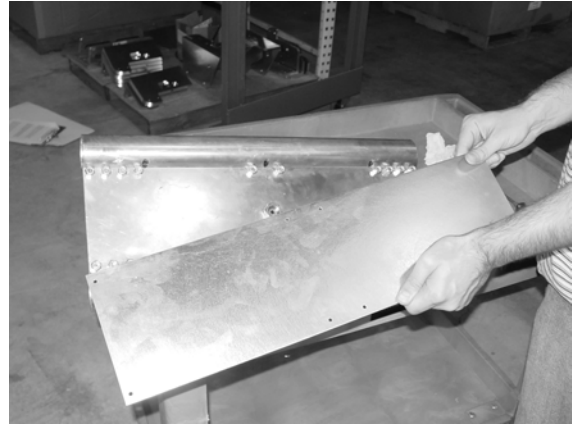

FIG. 2

Take one end of the 20' 18-4 shielded wire cable that was included with the tower and run it through the pedestal as shown in Fig. 3. Locate the black and red wires and cut back the insulation to the bare wire as shown. The other two wires within the cable (green and white) can be used for speakers and other lights if desired. Now take the other end of the wire cable and run it through one of the pre-drilled holes in the bottom of the header as shown in Fig. 4.



FIG. 3

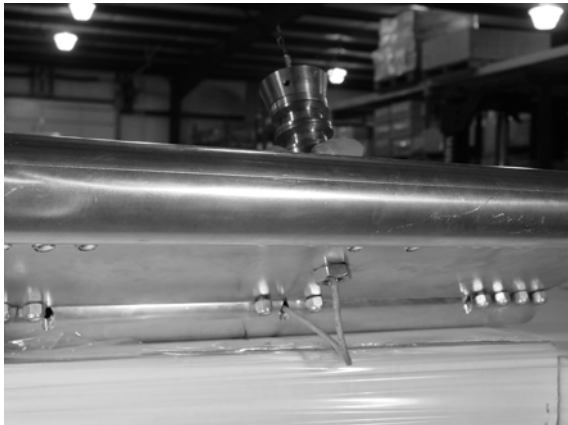

FIG. 4

Then out of the header and into the upper tube as shown in Fig. 5. Loosen the 3/8"-16 X 1-1/2" socket head cap screw on the clamp at the lower tube and remove the clevis pin (Fig. 6). Now continue to run wire cable through the lower tube as shown in Fig. 7. The clevis pin that you removed will have a pre-drilled hole for the wire cable to go through. Run the wire through that hole as shown in Fig 8. The special 1/2" bolt that mounts the clevis feet to the boat is hollow so the wire cable will easily go from the clevis pin and through this bolt into the boat for connection to the switch (see Fig. 9). Now insert the clevis pin into the lower tube and tighten clamp to secure. There is no need to reconnect the clevis feet to the clevis pins at this time. They will not be reconnected until the tower is mounted.

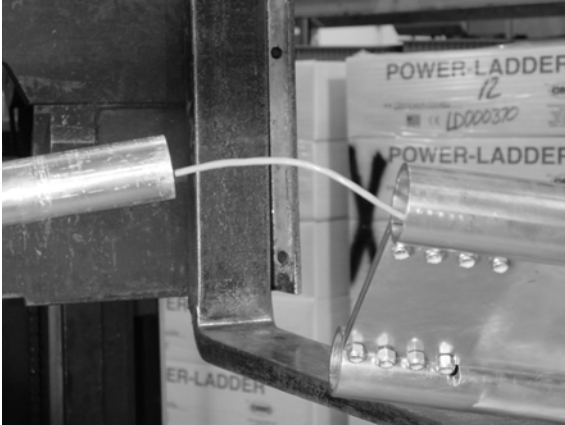

FIG. 5

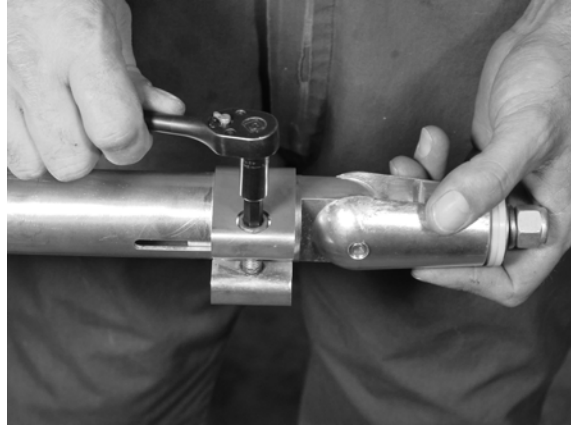

FIG. 6



FIG. 7



FIG. 8



FIG. 9



FIG. 10



FIG. 11

Remove the lamp lens by unscrewing it slightly counter clockwise. Now take the red and black wires at the other end of the wire cable that is through the pedestal and run them through the hole in the center of the bottom of the lamp. You will find two screws that are marked + and -. Connect the black wire to the - screw and the red wire to the + screw as shown in Fig. 10. Mount the lamp to the pedestal adapter with the three 6-32 X 3/4" Phillips pan head tapping screws provided with the light. Make sure that you use the three insulator washers to prevent a short (see Fig. 11). Attach the lamp cover to the light as shown in Fig. 12.



FIG. 12



FIG. 13

Next, loosen the twelve 3/8"-16 x 1" socket head cap screws on the header so that you can insert the upper tubes of the port and starboard front and rear tube assemblies as shown in Fig. 13. Insert all 4 of the upper tubes.

Tighten the 3/8"-16 x1"socket head cap screws on the header down snug but moveable just to hold the tubes in place while the tower is lifted onto the boat (Fig. 14). Remove the two 3/8"-16 X 3/4" socket button head cap screws from each of the starboard rear brace clamp and starboard front clamp. Then mount the brace plate over lapping the brace clamps on the outside of the tower as shown in Fig. 15. Follow the same procedure to mount the other brace plate to the port side.



FIG. 14



FIG. 15

To mount the wakeboard racks, first remove the 1/2"-13 X 3/4" socket button head cap screws from the wakeboard racks as shown in Fig 16. Mount the wakeboard rakes through the pre-drilled holes in the port and starboard brace plates of the tower as shown in Fig. 17. Make sure they are positioned to slant slightly upward as shown.



FIG. 16

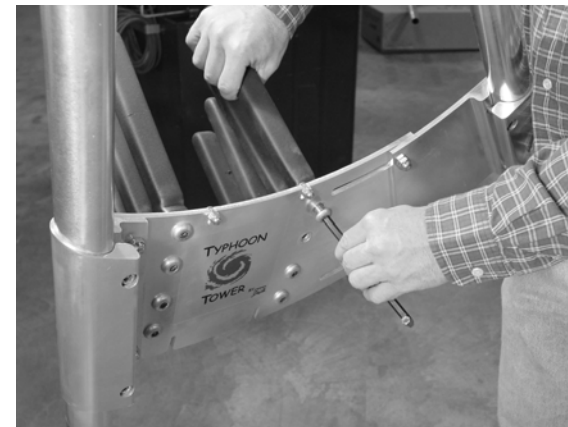

FIG. 17

MOUNTING THE TOWER TO THE BOAT

STEP 2: Decide where you want to mount the tower on the boat, within min. and max. dimensions shown in diagram 2, and mark the location to drill the holes. The first holes to be drilled into the boat for mounting will be the aft holes to mount the clevis feet of the port and starboard rear tube assemblies. The fiberglass that you are going to drill these mounting holes through must be a

minimum of 3/8" thick. If the fiberglass is not at least 3/8" thick, you will need to add fiberglass cloth to build up the thickness to at least 3/8". **FAILURE TO FOLLOW THESE INSTRUCTIONS MAY CAUSE SEVERE DECK DAMAGE.** Use care when working with fiberglass and resins and follow all manufacturers' instructions and safety procedures.

Drill a 1/2" hole on the port and starboard sides of the boat as shown in Fig. 18. Remove the clevis foot from the port rear tube assembly and the starboard rear tube assembly by removing the 3/8"-16 X 1-1/2" socket head cap screw from each as shown in Fig. 19. Insert the 1/2"-13 X 3" socket head cap screw that is part of the clevis foot into the 1/2" hole previously drilled as shown in Fig. 20, making sure to put the wear plates on both sides of the fiberglass. On the inside of the boat, other side of the fiberglass, after the 1/2" bolt from the clevis is the wear plate put the 1/2" nylon flat washer against the wear plate, then the 1/2" stainless steel flat washer, the 1/2" lock washer and finally the 1/2"-13 lock nut as shown in Fig. 21. When mounting the clevis feet, tighten them down, but leave them loose enough so you can swivel them. When you attach the clevis pin of the clevis foot to the lower tube of the port and starboard rear tube assemblies, leaving the clevis feet loose will make it easier to line it up with the tube.



FIG. 18



FIG. 19



FIG. 20



FIG. 21



FIG. 22



FIG. 23

NOTE: It is very important that you leave the bolts, clamps and clevis feet loose when attaching the tower to the boat. The clevis feet and clevis pins must be able to swivel. The 3/8"-16 x 1 socket head cap screws on the header must be loose to allow for any adjustments that may need to be made.

Connect (loosely) the clevis pins of the two clevis feet that are now mounted to the boat to the port and starboard rear tube assemblies using the 3/8"-16 X 1-1/2" bolts that were previously removed. See Fig. 22. Tilt the tower forward and connect the front clevis pins to the front clevis feet that were previously mounted as shown in Fig. 23.

Tighten all 3/8" bolts to 30 foot pounds of torque each. This includes the clevis feet, the clamps and the header bolts as shown in Fig. 24, 25, 26, and 27.

Mount the panel that was removed from the bottom of the header in step 1 and place the decals on the tower if so desired.



FIG. 24



FIG. 25



FIG. 26



FIG. 27

Next, locate the pre-drilled $\frac{1}{4}$ " hole that is machined on the side of the upper tube clamps. Using this $\frac{1}{4}$ " hole as a guide, drill a $\frac{1}{4}$ " hole through the tube on both sides as shown in Figs. 28 & 29. Insert the $\frac{1}{4}$ " – 20 x 2 $\frac{1}{2}$ " socket button head cap screw through the tube and clamp (Fig. 30). Put the $\frac{1}{4}$ " lock washer on the bolt, then the $\frac{1}{4}$ " – 20 hex cap nut and tighten as shown in Figs. 31 & 32. Do this on all four legs.



FIG. 28



FIG. 29



FIG. 30



FIG. 31

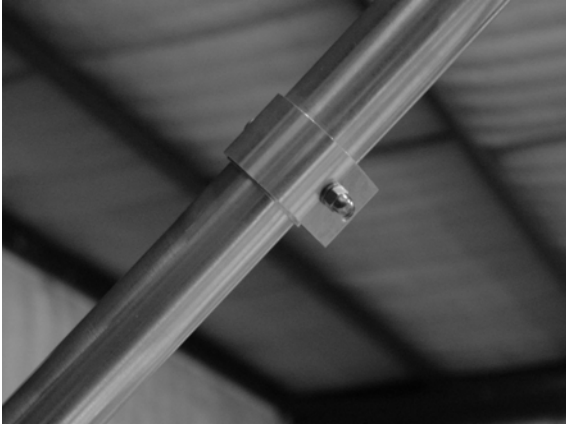

FIG. 32



FIG. 33

To secure the wake boards to the wake board racks, starting at the top of the brace plate, insert the end of shock cord assembly opposite the handle into the two machined slots as show in Fig. 33. Pull the shock cord over the boards and up into the two machine slots at the bottom of the brace plate (Fig. 34). Insert into these two slots as shown in Fig. 35.



FIG. 34

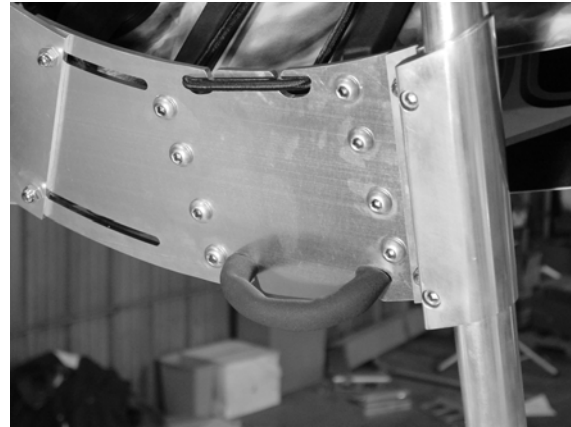

FIG. 35

STORAGE

The tower can be tilted forward or backwards for storage if desired. Remember, the wire cable must go through one of the pivot clevis feet so that the wires will not have to be disconnected. To tilt forward, remove the two 3/8"-16 X1-1/2" bolts from the clevis pins at the back and tilt forward as shown in Fig. 28. To tilt toward the back, remove the two 3/8"-16 X 1-1/2" bolts from the clevis feet at the front as shown in Fig. 29. Or remove the tower completely by taking all four of the clevis pins from the clevis feet.



FIG. 28



FIG. 29

LIMITED WARRANTY

New CMC Typhoon Towers are warranted by the manufacturer for one year from the date of purchase against defects in workmanship and/or materials.

This warranty means that only the parts that prove defective during the period of warranty will be repaired or replaced at our option. Cook Manufacturing Corporation will accept only parts returned for warranty prepaid from initial purchaser and return the repaired or replaced parts freight collect.

A return authorization number must be issued from the factory prior to return of defective parts. Call toll free in the continental United States 800-654-3697; outside the United States call 580-252-1699 to obtain the return authorization. There are no warranties which extend beyond the description on the face hereof. No one has authority to make any representations except those made in writing by Cook Manufacturing Corporation.

This warranty does not apply if damage occurs because of accident, improper handling or operation, abuse or misuse.

All liability for any incidental or consequential damage is expressly excluded here from.

In order to obtain the benefit of this warranty and agreement, the warranty card found in the centerfold of this manual must be completely filled out and mailed within 30 days to Cook Manufacturing Corporation.

This warranty applies to original ownership only.

COOK MANUFACTURING CORPORATION

3920 SOUTH 13TH ST.
DUNCAN, OKLAHOMA 73533

CUSTOMER SERVICE

580-252-1699

www.cook-mfg.com